

Hydrogen Peroxide Storage in Small Sealed Tanks

J.C. Whitehead

This article was submitted to
2nd International Hydrogen Peroxide Propulsion Conference, West
Lafayette, IN, November 7-10, 1999

October 20, 1999

U.S. Department of Energy

Lawrence
Livermore
National
Laboratory

DISCLAIMER

This document was prepared as an account of work sponsored by an agency of the United States Government. Neither the United States Government nor the University of California nor any of their employees, makes any warranty, express or implied, or assumes any legal liability or responsibility for the accuracy, completeness, or usefulness of any information, apparatus, product, or process disclosed, or represents that its use would not infringe privately owned rights. Reference herein to any specific commercial product, process, or service by trade name, trademark, manufacturer, or otherwise, does not necessarily constitute or imply its endorsement, recommendation, or favoring by the United States Government or the University of California. The views and opinions of authors expressed herein do not necessarily state or reflect those of the United States Government or the University of California, and shall not be used for advertising or product endorsement purposes.

This is a preprint of a paper intended for publication in a journal or proceedings. Since changes may be made before publication, this preprint is made available with the understanding that it will not be cited or reproduced without the permission of the author.

This report has been reproduced
directly from the best available copy.

Available to DOE and DOE contractors from the
Office of Scientific and Technical Information
P.O. Box 62, Oak Ridge, TN 37831
Prices available from (423) 576-8401
<http://apollo.osti.gov/bridge/>

Available to the public from the
National Technical Information Service
U.S. Department of Commerce
5285 Port Royal Rd.,
Springfield, VA 22161
<http://www.ntis.gov/>

OR

Lawrence Livermore National Laboratory
Technical Information Department's Digital Library
<http://www.llnl.gov/tid/Library.html>

Hydrogen Peroxide Storage in Small Sealed Tanks

John C. Whitehead
Lawrence Livermore National Laboratory
L-43, PO Box 808
Livermore, CA 94551
925-423-4847
jcw@llnl.gov

Abstract

Unstabilized hydrogen peroxide of 85% concentration has been prepared in laboratory quantities for testing material compatibility and long term storage on a small scale. Vessels made of candidate tank and liner materials ranged in volume from 1 cc to 2540 cc. Numerous metals and plastics were tried at the smallest scales, while promising ones were used to fabricate larger vessels and liners. An aluminum alloy (6061-T6) performed poorly, including increasing homogeneous decay due to alloying elements entering solution. The decay rate in this high strength aluminum was greatly reduced by anodizing. Better results were obtained with polymers, particularly polyvinylidene fluoride. Data reported herein include ullage pressures as a function of time with changing decay rates, and contamination analysis results.

Introduction

High test hydrogen peroxide (HTP) can be used as a monopropellant or as an oxidizer. Its minimally hazardous nature is a major advantage for either. Unfortunately, its instability is generally a disadvantage. Decades ago, compatible materials were sought for long term storage. Historically, compatibility ratings and normalized decay rates were documented in tabular form. Usefulness is, to some extent, limited to comparative purposes. For example, many of these data were obtained at elevated temperatures to shorten test durations. Changing decay rates are not represented in data tables. For such reasons, it is difficult to predict actual storage capability in sealed tanks. In particular, the pressure rise curve is the critical information of interest, since it determines how long a tank can remain unvented.

HTP storage drums have traditionally been made of unalloyed aluminum. In contrast, high strength alloys are favored for flight tanks to reduce weight. Thus the pressure rise and decay mechanisms in alloyed aluminum are of interest. If excess oxygen can be occasionally vented from flight tanks, decay rates below a reasonable minimum are not critically important. Historically, HTP tanks in some propulsion systems were fitted with a pressure relief valve feeding a small catalyst bed.¹ Thus, only oxygen and water vapor would be released. Presently, flight rules prohibit venting or at least discourage it more than ever. The most stringent rules are for NASA's space shuttle, where polymer lined tanks may be appropriate.

The present work is motivated by an interest in using HTP to propel very small satellites. Laboratory storage test vessels can be sized to represent actual flight tanks, which directly indicates time limits on sealed storage. Safety considerations, propellant preparation, test methods, and storage results are all explained herein for the sake of completeness. While most aspects of the work may not be highly original, it is at least current first hand experience with many details offered.

Propellant Hazard Experience

As a monopropellant, pure H_2O_2 decomposes to oxygen and superheated steam just above 1800 F in the absence of heat losses. The adiabatic decomposition temperature is almost 1200 F for 85 percent solutions by mass in water (85% HTP). Superheated steam can be very dangerous. As with any rocket work, hot hardware is a hazard by itself.

The decay products of HTP, oxygen and water, are obviously completely nontoxic and can have no long term harmful effects. H_2O_2 is listed as a hazardous material by the State of California, so its release into the environment is required to be controlled. However, most environmental professionals working in the water resources field readily acknowledge that there are no long term harmful effects of HTP. The accumulation of unwanted metals, salts, and harmful organics in natural waters, for example, is a far greater concern. Dilution of HTP spills renders them nonhazardous, although this can be construed as unauthorized treatment of hazardous waste. It is ironic that H_2O_2 is deliberately added to natural waters during sewage treatment and groundwater remediation. This is done under license at specifically permitted locations.

In practice, the most prevalent hazard of HTP is skin contact with droplets too small to notice. Temporary white spots on the skin are sometimes painful and should be rinsed with cold water. Similar effects on the eyes and lung tissue are more important to avoid. Fortunately, the vapor pressure is extremely low (2 mm Hg at 20 C). Benchtop ventilation readily keeps concentrations below the 1 ppm breathing limit (OSHA TLV). In the author's laboratory, HTP is poured in liter sized quantities between open containers, over secondary containment trays. In contrast, $N_2 O_4$ and $N_2 H_4$ propellants must be kept within sealed systems, and special breathing apparatus is often used anyway. This is due to their much higher vapor pressures and a 0.1 ppm breathing limit for the latter, with possible carcinogenicity.

Regarding protective clothing requirements, cumbersome suits may increase the likelihood of spills. It seems appropriate to defer to personal preference when only small quantities are handled. For example, working with wet hands near running water has been found to be a satisfactory alternative to gloves, which can potentially contain spills against the skin.

During the course of the present work, a literature search was conducted in order to better understand HTP hazards. One question was the detonability of HTP. Safety handbooks and even some technical literature include undocumented references to detonation and spontaneous combustion. Fortunately, some meticulous work was done by chemical engineers and chemists at MIT circa 1950.^{2&3} Although bulk liquid HTP does not propagate decomposition,⁴ highly concentrated vapor can be detonated by an ignition source. Reference 2 quantified the required conditions, so they can be avoided. In the atmosphere, 100% HTP must be raised at least to 112 C in the absence of ventilation to make detonable vapor (>120 C at 85%). Reduced pressures require higher vapor phase concentrations for detonation to be possible.

When gaseous $H_2 O_2$ detonates, there are suddenly 1.5 times as many molecules at roughly 5 times ambient temperature. Thus, the products necessarily occupy less than 10 times the original vapor volume. This is entirely different from solid or liquid explosives, which expand thousands of times. If the volume is constrained, the pressure similarly remains within an order of magnitude. In particular, note that a vacuum distillation apparatus below 100 torr cannot explode.

A sustained, invisible, thermal decomposition flame can occur in the vapor above liquid HTP. The author observed this in a beaker containing HTP near its boiling point. Rapid ventilation prevented the accumulation of a dangerous quantity of detonable vapor above the beaker. The gaseous HTP within the beaker was ignited with a hot wire. The energy released by decomposition steadily vaporized more liquid to feed the flame, which could empty a 1-liter beaker in tens of seconds.

Avoiding contamination is especially important for HTP, because there is the potential for both decomposition and combustion if both catalytic and flammable substances are present. Combustible mixtures of HTP and fuel can burn with thermal ignition. Concerns are minimal on a small scale, due to heat dissipation. For example, wet spots on cloth and absorbent paper have been shown to stop small flames, since HTP has a high heat capacity. Drops of HTP and kerosene placed in contact with one another do not react or even mix since kerosene is hydrophobic and HTP is hydrophilic.

An important hazard related to the subject of this paper is overpressurization of containers by gradual decomposition. All HTP storage containers must have a vent or a relief valve to release evolved oxygen. Flight tanks need continuous pressure monitoring in the absence of passive relief devices.

Preparation for Concentration and Purity

Hydrogen peroxide is commercially available in a wide range of concentrations, purities, and quantities. Unfortunately, this does not include small containers of propellant grade HTP. Large drums are sold, but both availability and impurities have been variable. Also, handling larger quantities than needed can be burdensome in a small lab.

Food grade 35% hydrogen peroxide is purchased in 4-liter polyethylene containers. It is first concentrated to 85% and then purified, using the apparatus shown in Figure 1. This variation of a previous method⁵ simplifies the apparatus and reduces glassware cleaning. Operation is automated, so only daily emptying and filling of vessels is required to yield 2 liters over a regular work week. Certainly the cost per liter is high, but the total is still affordable on a small scale.

First, a pair of liter size beakers on hot plates are used to preferentially evaporate water during a timer-controlled period of 18 hours. The volume in each beaker is quartered to 250 cc, or about 30% of the initial mass. One fourth of the initial $H_2 O_2$

molecules are lost as vapor. The loss increases with concentration, so 85% is a practical limit for this process. Calculations and measurements indicate a very high degree of safety for the actual production rates. In Figure 1, air is drawn into the horizontal exhaust slots behind the apparatus. Vapor concentrations below 10 ppm were measured directly above the concentrating beakers.



Figure 1. Evaporative concentration and vacuum distillation.

Table 1. Analysis of Hydrogen Peroxide Solutions in 1997.

Constituent	Purchased	Conc. & Distilled
H ₂ O ₂	35% by mass	85%
Ca	.01 mg/kg	.03 mg/kg
K	2.6	<0.1
Na	1.2	<0.1
P	3.9	<0.5
S	.04	.05
Sn	3.7	.08
Ammonium	1.13 mg/l	<0.4 mg/l
Nitrate	4.7	5.9
Phosphate	7.4	<.02
Sulfate	0.4	1.6
TOC	<0.1 mg/kg	<0.1 mg/kg

Not detected at thresholds between .01-0.1 ppm:

Al Ag Ba Br Cl Cu Cr F Fe Mg Mn Ni Si Zn

Not detected at threshold 0.5 ppm: Pb

If a hot plate thermostat failed ON during a shutdown of the ventilation system, detonable vapor could accumulate. To avoid this possibility, the two 750 watt hot plates were simply connected in series after it was noticed that they typically operated on a 25% duty cycle. Series wiring halves both voltage and current, which quarters the power. Thus, the thermostatic switches remain closed, and the safe operating temperature is the maximum possible.

To the left of the evaporation beakers is an off-the-shelf rotary evaporator. The 85% solution having ~80 ppm concentrated impurities is heated in 750 cc batches by a water bath at 50 C. The sealed glassware is held internally below 10 mm Hg, so distillation is complete after 3-4 hours. Condensate drips into the flask at lower left with <5% loss.

A dual water aspirator is visible behind the glassware. One port pulls the vacuum, while the other circulates water through a chiller, the condenser coils, and the aspirator bath itself. A temperature just above freezing improves both condensation and the aspirator's vacuum capability. Vapors which escape the condenser are rendered harmless by dilution.

Pure hydrogen peroxide (100% HTP) is much denser than water (1.45 at 20 C), so a floating glass hydrometer (range 1.2-1.4) readily indicates concentration to within 1%. In 1997, both the purchased product and the distilled HTP were analyzed for impurities, as shown in Table 1. This included plasma emission spectroscopy, ion chromatography, and a total organic carbon (TOC) analysis. Note that phosphate and tin are stabilizers, and they are apparently introduced as salts of K and Na.

The apparatus and procedures have remained essentially unchanged over two years. In 1999, samples of the prepared HTP were concentrated to obtain more accurate results with plasma emission spectroscopy. All numbers reported in Table 2 are at least 3 times the detection limit. Data are consistent with Table 1 except for less calcium. Thus, there is confidence that the HTP being used in experiments is consistent.

Table 2. Improved Analysis of Concentrated & Distilled HTP in 1999 (ppb).

Element	Amount	Element	Amount
Al	10 ng/g	Na	13 ng/g
Ba	0.2	Ni	0.2
Ca	7	P	25
Cr	0.2	Pb	0.4
Cu	0.4	S	20
Fe	2	Si	1
Mg	2	Sn	7
Mn	0.1	Zn	1

Material Compatibility and HTP Decay

Compatibility between HTP and materials of construction includes two separate problems to be avoided. HTP exposure can cause material degradation, as occurs with many polymers. Also, the rate of HTP decay varies widely with exposure to different surfaces. In both cases, detrimental effects require significant periods of time. Therefore, compatibility must be quantified and considered in context, rather than being treated as a yes or no question. For example, a thrust chamber may be constructed of a metal which would be considered incompatible for tankage.

Historical work includes compatibility tests with material samples in glass containers of HTP.⁶ This and other literature contains a wealth of data. However, much of it is useful mainly for relative comparisons, e.g. many tests were unsealed and many were performed at elevated temperatures to speed them up. Typically, results were normalized to fractional active oxygen loss (AOL) rates. Pure hydrogen peroxide contains 47% active oxygen by mass (40% for 85% HTP). Changes in AOL rates over time are not evident in tabulated data. Overall, it is difficult to predict actual pressure rise rates in flight tanks using the existing information.

Decay can occur on tank walls (heterogeneous), or throughout the liquid (homogeneous).⁷ The relevant factors include tank wall (or liner) material, the volume/surface ratio (tank size), temperature, and propellant purity. The actual pressures which are encountered in service additionally depend on the ullage volume, and the storage and consumption timeline. For unvented tanks in service, the primary concern is pressure buildup, not the loss of propellant performance through reduced HTP concentration. For example, it is readily calculated that only 1% decay of 85% HTP ("1% AOL") raises the pressure of a sealed 20% ullage volume to 241 psi at 20 C (but some O₂ also remains in solution). This rule of thumb holds for any vessel size, while scaling affects decay rates because volume-to-surface ratios change.

This present work is application oriented, so the actual pressures are graphed herein. Such information is notably absent from Reference 7, and raw pressure data presented elsewhere does not include complete information to make it useful, such as the storage temperature and ullage fraction.⁸ In addition to the value of representing flight tanks in service, there's another reason to seal HTP storage test vessels when it is of interest to accurately measure very low decay rates. HTP in unsealed containers can exchange matter with the atmosphere (examples in following two paragraphs). Even if sealed containers have leakage or permeation losses, it is certain that atmospheric constituents cannot enter them when pressurized.

In 1997, three small vessels were machined from fluoropolymers including unsealed lids of the same material. They were filled partly with 85% HTP (stabilized at the time) and left undisturbed on a benchtop at 21±1 C. A thin walled PVDF vessel containing 125 g of HTP gained 8 g in 1.5 years, and an additional gram over the following year. A 40 gram sample in a thicker container gained 0.2 g over 4 months then lost 0.9 g over 2 years. An identical thick-walled vessel made of PCTFE contained 42 g of HTP and gained 2 grams over 2 years at a roughly constant rate. Results remain unexplained.

The distilled HTP described above is stored in 4-liter polyethylene bottles, which have expanded PTFE ("Goretex") vent membranes. One containing 1.7 kg of 85% HTP (680 grams active oxygen) was regularly weighed between March and October of 1999. In the first 10 weeks, the mass decreased by only 0.1 g but 0.5 g was missing after 26 weeks. In just 4 more weeks, an additional 0.5 g was missing! The calculated decay rate ranges from .07% to 0.9% AOL/year.

Methods and Test Vessels

Various small sealed cylindrical containers have been constructed of materials to be tested. A capability not available decades ago is that electronic analytic balances are now accurate enough to observe gas permeation and leakage losses, as well as verifying expected mass changes upon deliberate venting. Vessels having volumes of 1 cc and 5 cc were weighed with .01 g accuracy, while balances used for the larger ones were accurate to about 0.1 g. All test cylinders were sealed using fluoroelastomer "Viton" o-rings, with negligible mass losses in many cases. In keeping with the goal of avoiding hazardous materials, all parts were simply washed with detergent and warm water followed by demineralized water rinsing.

Figure 2 shows a 5 cc sample cup next to an assembled vessel corresponding to the cross section diagram. The unalloyed aluminum cover deformed with pressure, raising the pressure indicator above the top of the vessel (a calibration curve was determined separately). The cover also served as a safety burst disk. The samples were simply inch long pieces of inch bar stock, with a 3/4 hole drilled 3/4 deep. Similar 1 cc vessels used half inch bar.

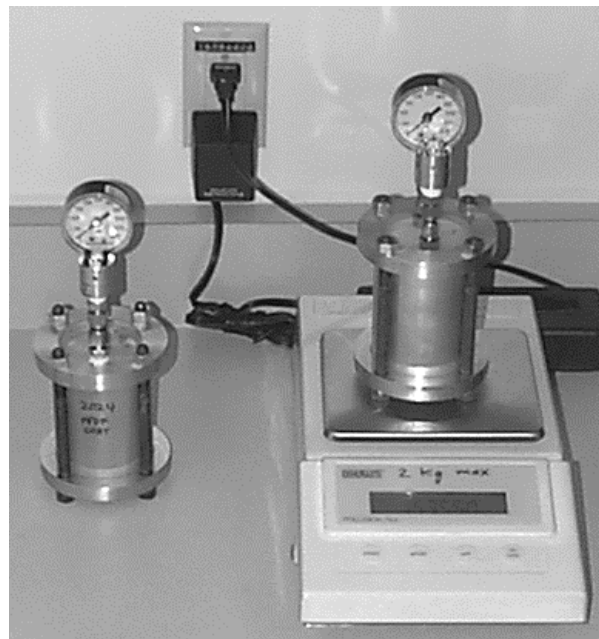
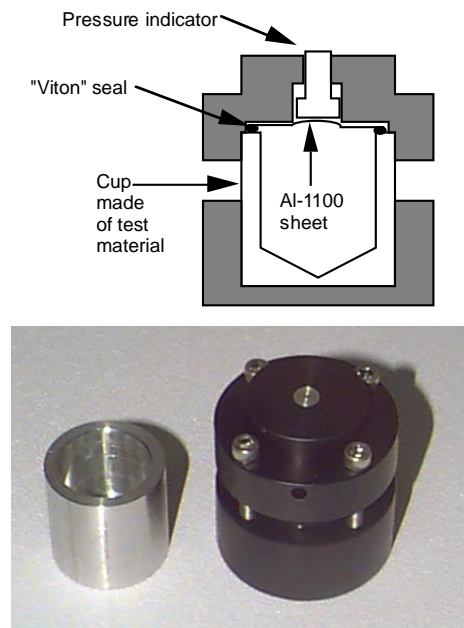

Figure 2. Test vessel, 5 cc, and complete assembly. Figure 3. Test vessels using 3 inch Al tube, 300 cc volume.

A key goal was to demonstrate months of sealed storage, so vessels having higher volume-to-surface ratios were required. Figure 3 shows 300 cc test articles made with 3 inch aluminum tubing, some of which had machined PVDF liners. A polycarbonate vessel was fabricated from 3 inch diameter bar. A 2.5 liter aluminum tank used in a propulsion system was also tested. This vessel is pictured in a companion paper⁹ but no internal piston was used for storage tests. In all cases, a pressure gauge and a safety burst disk were included.

Compatibility Screening

Considering materials which are affected detrimentally by HTP, initial testing on a small scale proved to be appropriate. Effects such as swelling or weakening become readily apparent when the material being tested is the container wall itself. For example, both acrylic (PMMA) and acetal ("Delrin") had large amounts of hoop strain in 1 cc test vessels.

Fluoropolymers such as PTFE (polytetrafluoroethylene), PCTFE (polychlorotrifluoroethylene), and PVDF (polyvinylidene fluoride) do not degrade in HTP. They also result in slow decay of the propellant, so these materials make sense for tank coatings, liners, or bladders, if months to years of storage are required. PTFE has poor mechanical properties and PCTFE ("Kel-F") is expensive, so PVDF ("Kynar") was tested the most extensively (also it's less dense). Fluoroelastomer o-ring seals (standard "Viton") and fluorinated greases have withstood years of HTP exposure in these tests. Smearing "Krytox" grease inside one of the 5 cc vessels reduced the HTP decay rate slightly. Polycarbonate plastic is surprisingly unaffected by HTP. This non-brittle material has been used where its transparency is an asset, e.g. for tanks where the liquid level must be visible. PEEK (polyetheretherketone) did not degrade in a 1-month test.

Several aluminum alloys were tested at 1 cc and 5 cc. HTP preserves untreated aluminum surfaces for many months. This is in contrast to water, which reacts to form aluminum hydroxide. In 1997, alloy 5086 performed poorly, followed by 2024, with 6061 being slightly better. All three performed worse after eight minutes in 10% HNO₃, so acid cleaning was not pursued further. This decision may need to be reexamined in light of more recent results below.

The ideal HTP tank would have strong metal or composite walls with a plastic liner or coating (the latter being the lightest). Polyparaxylene ("Parylene") and PVDF coatings were tried, but unfortunately both peeled. HTP apparently permeated the plastic and decomposed between the metal and its coating. A similar bubbling effect occurs if HTP is left in a 2-liter PET soft drink container for several days. This is unfortunate, since this particular container is a relatively high performance pressure vessel. Another spectacular material screening result is that HTP in contact with titanium becomes yellow, quite possibly the result of TiO in solution.

Long Term Sealed Storage

The goal of ongoing work has been to demonstrate 6 months to a year or more of sealed storage in tanks sized for very small spacecraft. This is sufficient to cover prelaunch timelines and on-orbit health checks of a satellite. If initial maneuvers consume most of the HTP, then the ullage volume increases and subsequent pressure rises occur more slowly.

Recent results include carefully recorded decay data at 21 ± 1 C for vessels in the 0.2 to 2.5 liter range. These tests used 85% distilled HTP initially occupying 80% of the volume. This permitted the test vessels to be moved for weighing without wetting the top of the vessel where the pressure gauges were connected. Pressure and mass were recorded weekly. The impurities in the HTP were analyzed after several of the tests.

Uncoated Aluminum 6061-T6

Figure 4 presents initial results for a 2.5 liter aluminum tank. Each time the pressure approached 300 psi, the oxygen was simply vented so testing could continue. The key fact shown here is that the decay rate was initially high and it increased over time. During vented periods, the effective pressure rises (dashed lines) were calculated from mass losses.

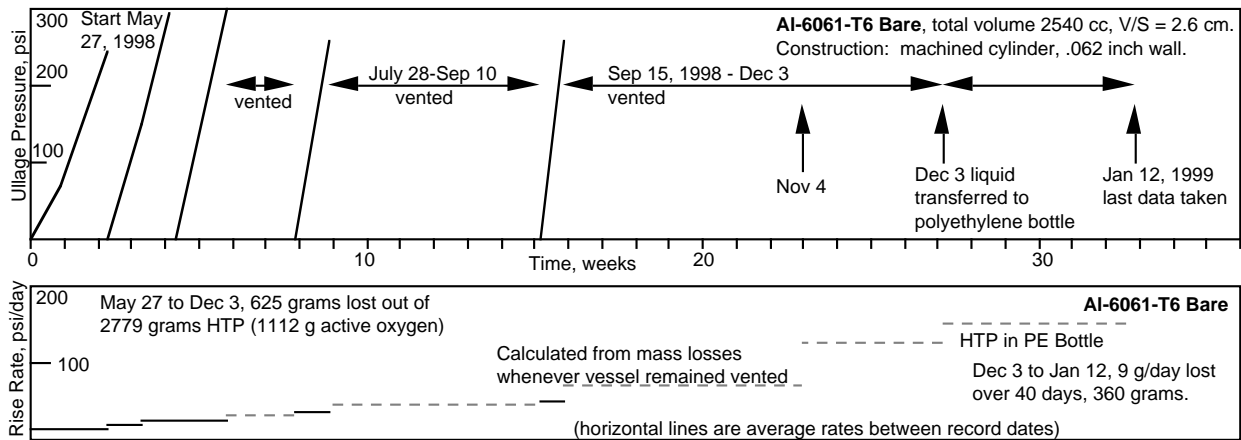

Figure 4. Sealed storage in uncoated aluminum 6061-T6, 2540 cc total volume. Initial distilled HTP fill was 2032 cc, 2779 grams (1112 g active oxygen). Ullage volume 508 cc (20%) holds 13.8 grams O₂ at 300 psi.

Table 4. Analysis of HTP stored in uncoated Al-6061-T6 May-Dec 1998 (ppb).

Table 3. Alloy 6061.		Element	Amount	Element	Amount
Al	.98	Al	9600 ng/g	Na	23 ng/g
Cr	.0020	Ba	0.9	Ni	4
Cu	.0027	Ca	31	P	12
Mg	.010	Cr	16	Pb	19
Si	.006	Cu	39	S	30
		Fe	160	Si	160
		Mg	670	Sn	21
		Mn	27	Zn	28

After 27 weeks, the propellant was transferred into polyethylene, but the decay rate determined from mass measurements did not fall. This suggested that the fluid had become contaminated by the aluminum tank, resulting in homogenous decay. The alloy constituents are displayed in Table 3. Data from inductively coupled plasma (ICP) emission spectrometry in Table 4 confirms that the metals went into solution. Note that while 39 parts per billion of copper for example seems miniscule, it is equivalent to a 0.16 mm cube of copper (a visible speck) dispersed throughout each liter of HTP. While Al, Cu, and Cr in solution are roughly in proportion to their presence in the alloy, there is over twice the Si, and Mg is over-represented by a factor of 7.

The obvious next question was whether the tank wall had been "cleansed" by the 6-month exposure to HTP. In April 1999, the same vessel was taken out of storage and retested. In Figure 5, the rate of pressure rise and its positive derivative are both lower than in Figure 4. Analysis after 24 weeks (Table 5) turned up 2.5 to 4 times fewer aluminum constituents.

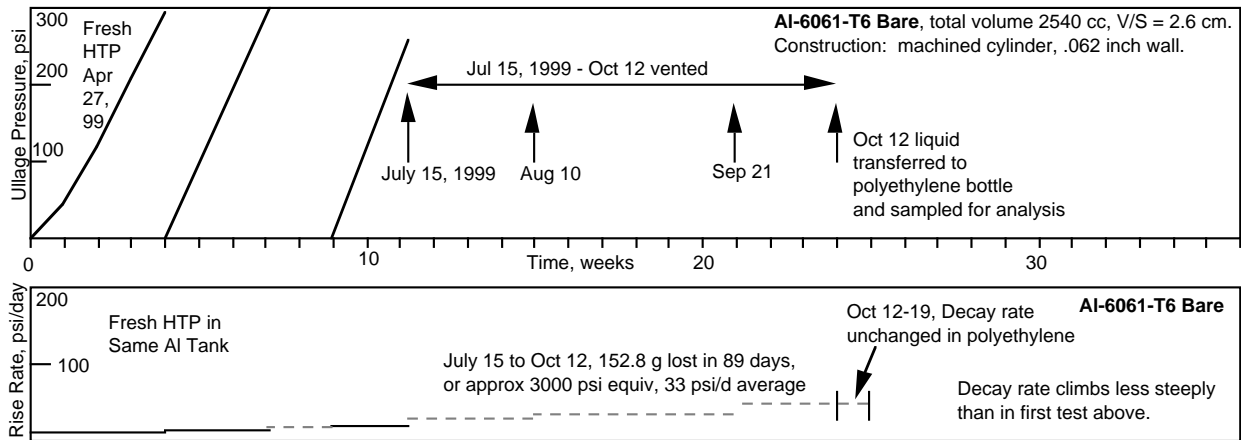

Figure 5. Retest of Figure 4 vessel with fresh distilled HTP (2036 cc, 2757 g).

Table 5. Analysis of HTP stored in uncoated Al-6061-T6 Apr-Oct 1999 (ppb).

Element	Amount	Element	Amount
Al	3700 ng/g	Na	8 ng/g
Ba	0.2	Ni	0.8
Ca	8	P	4
Cr	5	Pb	0.8
Cu	10	S	16
Fe	46	Si	46
Mg	37	Sn	4
Mn	8	Zn	6

The decay rate at the end of this 1999 test relative to that of the previous test was reduced by a factor near 3, similar to the reduction in contamination. Magnesium (as well as copper) is proportionately represented in the solution analyzed for Table 5. Chromium is slightly under represented, while the silicon in solution is again twice the expectation.

Anodized Aluminum 6061-T6

Given that dissolution of the alloy increases HTP decay, it makes sense to consider coatings. Given the poor luck with polymer coatings noted previously, anodizing had become a subject of interest by late 1998. Figure 6 shows that anodized aluminum has a decay rate much lower than the untreated surface for the same test in otherwise identical vessels (note the 8x magnified scale in the lower graph). Exposure of HTP to aluminum ended after only 16 weeks, but the 6061 elements in solution are greatly reduced for the most part. In Table 6, most of the alloying elements are represented an order of magnitude more strongly than aluminum, when compared to the alloy composition.

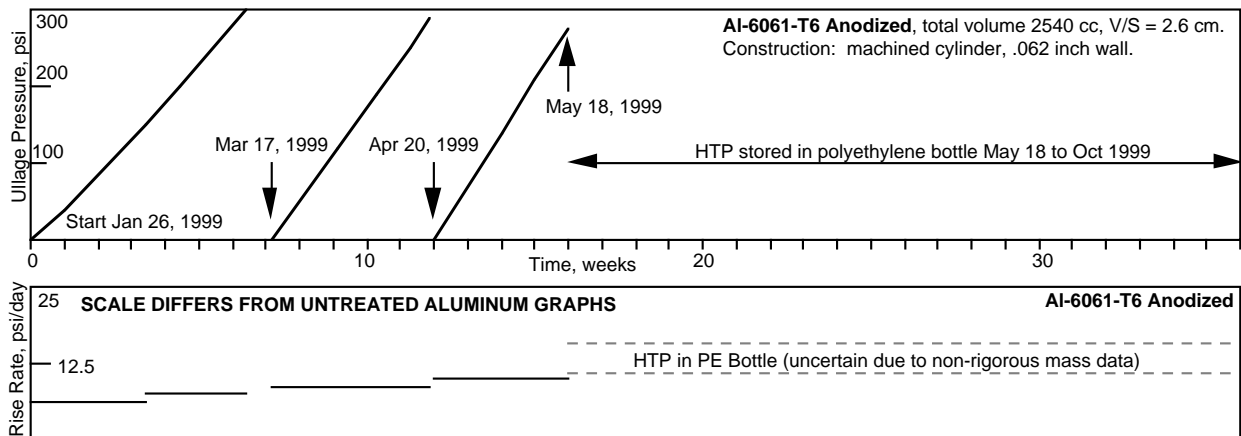

Figure 6. Sealed storage in anodized aluminum 6061-T6, 2540 cc. Initial distilled HTP fill was 2048 cc, 2818 grams.

Table 6. Analysis of HTP stored in anodized Al-6061-T6 Jan-May 1999 (ppb).

Element	Amount	Element	Amount
Al	340 ng/g	Na	21 ng/g
Ba	0.3	Ni	2.4
Ca	42	P	4
Cr	1.4	Pb	3
Cu	13	S	25
Fe	0.6	Si	26
Mg	11	Sn	7
Mn	0.4	Zn	15

The aluminum-oxygen bonds in the coating most likely kept this metal out of solution. Considering the 3x reduction in the final decay rate (Fig 6 vs. Fig 5), it is notable that Mg and Cr are roughly 3x lower in Table 6 than in Table 5. In contrast, the copper content apparently increased. Any conclusions drawn from this would of course be very preliminary.

The anodized tank was retested and its fluid was sampled after 19 weeks, as indicated in Figure 7 and Table 7. Once again, the decay rate and the concentrations of metals in solution decreased. A third test was started on Sep 28, 1999 (Figure 7). Initial results are similar to the month beginning on May 18.

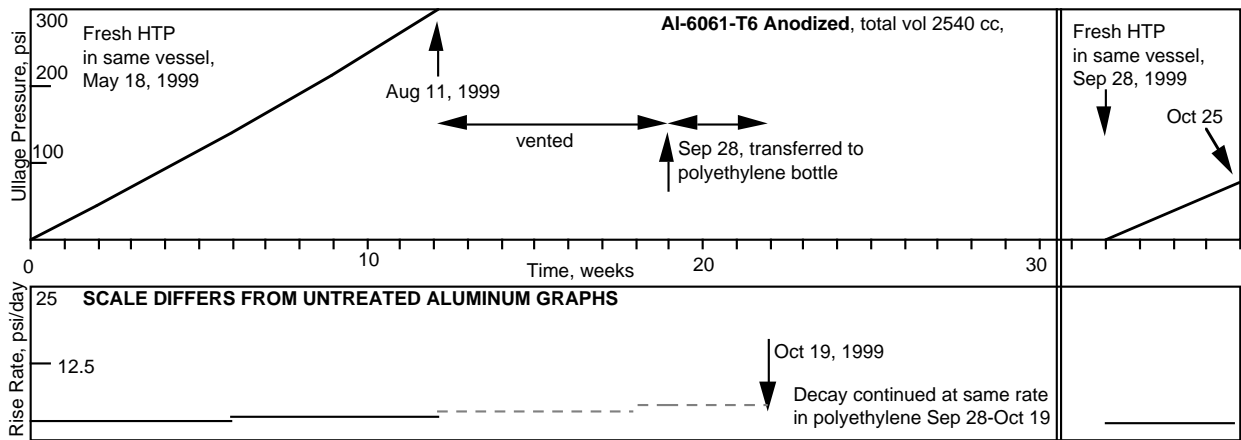

Figure 7. Retests of Figure 4 vessel with fresh distilled HTP (2030 cc, 2782 grams).

Table 7. Analysis of HTP stored in anodized Al-6061-T6 May-Sep 1999 (ppb).

Element	Amount	Element	Amount
Al	250 ng/g	Na	12 ng/g
Ba	0.2	Ni	0.5
Ca	12	P	2
Cr	0.4	Pb	1.1
Cu	3	S	26
Fe	1.3	Si	11
Mg	4	Sn	3
Mn	0.3	Zn	5

As an example of the low mass losses achieved in most tests of the metal tanks sealed with o-rings, less than 0.1 gram was missing after the 12 week test. On August 11, 1999, 15 g escaped upon venting, so 1 gram of oxygen was most likely in solution (the ullage was calculated to contain 13.8 grams of O₂).

Plastic Results

Both polycarbonate and PVDF were tested on a scale larger than 5 cc but with about 10 times less volume than the above aluminum tanks. The less favorable (~halved) volume-to-surface ratios should be kept in mind when comparing slopes in Figures 8 and 9 to the aluminum graphs. It is unknown whether the (relatively) high mass losses resulted from leakage or permeation.

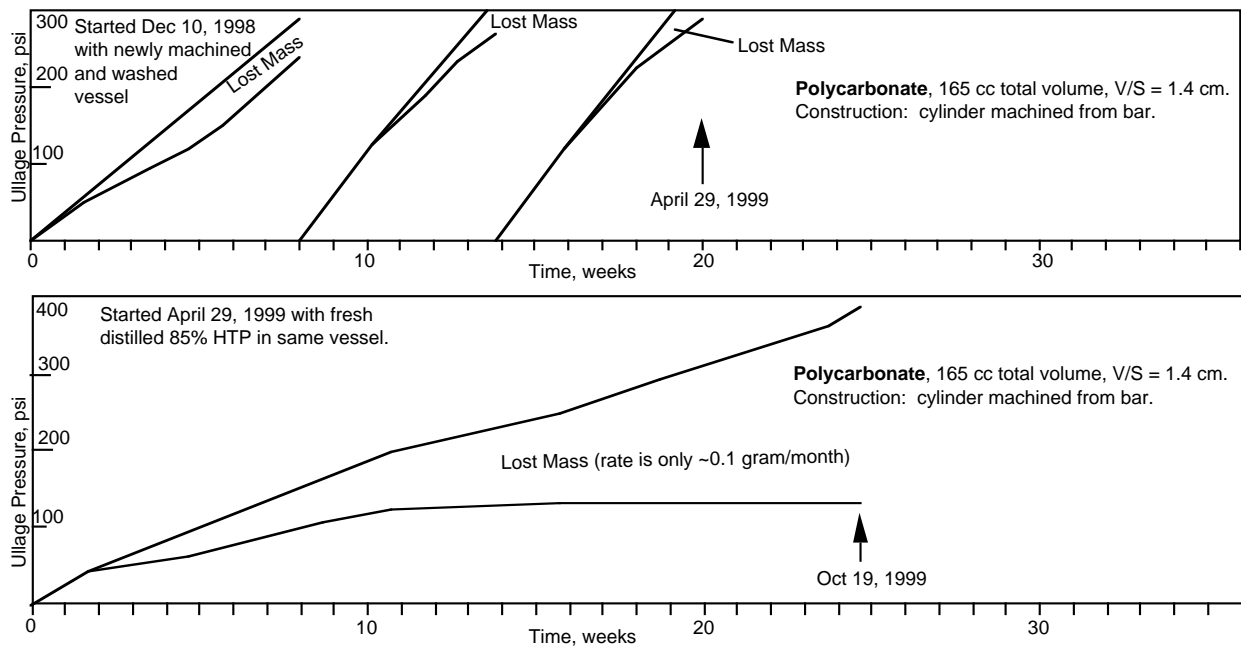

Figure 8. Sealed storage in transparent polycarbonate, 164 cc total volume. Initial distilled HTP fill was 131 cc, 178 grams (71 g active oxygen). Ullage volume 33 cc (20%) holds 0.9 grams O₂ at 300 psi. Lower curves represent the actual pressure, while the upper curves are calculated, assuming that the lost mass would have been oxygen in the ullage.

Of all the materials tried, PVDF clearly offers the most potential for a year of sealed HTP storage. Prior to the Figure 9 test, the vessel liner had been exposed to (stabilized) HTP for 22 months. It had been bleached to a color whiter than the original almond color which is characteristic of PVDF as purchased. The importance of this fact is presently unknown.

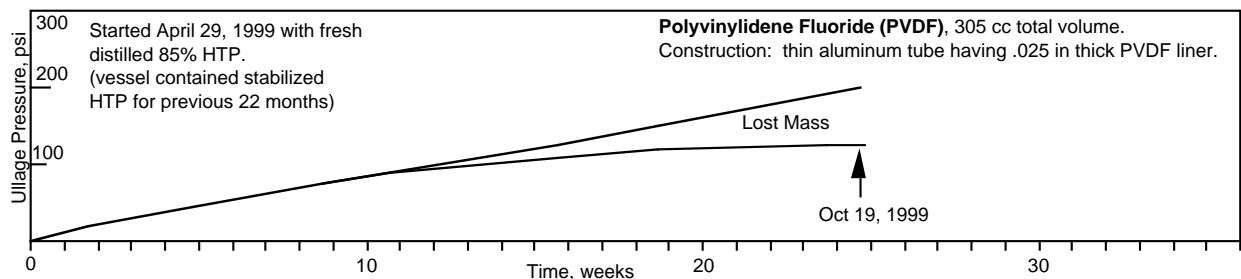

Figure 9. Sealed storage in PVDF-lined aluminum vessel, 305 cc total volume. Initial distilled HTP fill was 244 cc, 330 grams (132 g active oxygen). Ullage volume 61 cc (20%) holds 1.7 grams O₂ at 300 psi.

Both of these plastic tests continue, and an ongoing activity is to fabricate larger aluminum tanks lined with PVDF. Based on measurements to date, one-year unvented storage is within reach for tanks designed to have similar pressure limits and ullage fractions.

Discussion

Long term pressure rises resulting from unstabilized HTP in sealed containers have been documented in detail, because this is the most realistic material compatibility test relevant to spacecraft tanks. The 20% ullage fraction is probably a practical compromise to avoid thicker walls which would be required to contain higher pressures at reduced ullage volumes.

Anodized high-strength aluminum tanks might be appropriate for HTP if prelaunch timelines are short and consumption begins soon after reaching orbit. Storage times could be extended if prelaunch venting of a few grams of oxygen can be permitted, as was routine in the past for HTP systems. Metal tanks can be lighter and simpler than plastic-lined tanks.

Clearly, further cleansing of anodized aluminum alloy tank walls is a subject of great interest, as the results herein don't rule out further improvements. Historical cleaning procedures which use hazardous liquids have all but been ignored by the author, and it is entirely possible that they are of utmost relevance. However, given that the goal is to remove metals which will dissolve in HTP, it may not be an error to simply use HTP itself for this purpose.

The potential value of stabilizers in metal tanks should not be entirely ruled out, to the extent that they mitigate the catalytic effect of metals in solution. However, Reference 3 for example noted that the ideal situation for long term storage is pure HTP in a clean container having no catalytic activity. Unstabilized HTP is also the best for long thruster life.

Considering plastic tanks, the data presented herein suggest the possibility that polymer permeability might provide a "self-venting" capability. This needs to be explored further, but it may or may not be in accordance with safety concerns.

A complete treatment of long term storage in flight tanks is beyond scope here. For example, decay increases with temperature, so flight tanks should be tested under representative conditions over appropriate times. It may even be possible to store HTP indefinitely if it is permitted to freeze on long space missions. It does not expand and rupture hardware upon freezing as water does. The HTP storage problem needs further work, so it is comforting that there are ongoing programs which are considering the placement of HTP tanks in the space shuttle orbiter bay, e.g. X-37.¹⁰

Acknowledgments

Thanks are owed to David Silberman and Terry Duewer for expert ICP analysis. This work was part of LLNL's MicroSat Technologies Program supported by the U.S. Air Force Research Laboratory. This work was sponsored by the U.S. Government and performed by the University of California Lawrence Livermore National Laboratory under Contract W-7405-Eng-48 with the U.S. Department of Energy.

References

1. Anon., "Spacecraft Flight Control Systems," A Presentation of Walter Kidde & Company, circa 1967.
2. Satterfield, C.N., G.M. Kavanagh, & H. Resnick, "Explosive Characteristics of Hydrogen Peroxide Vapor," *Industrial and Engineering Chemistry* 43:11, pp 2507-2514, 1951.
3. Schumb, W.C., C.N. Satterfield, & R.L. Wentworth, "Hydrogen Peroxide," Reinhold Publishing, New York, 1955 (reprinted by University Microfilms).
4. Bloom, R., "On the Hazards of Concentrated Hydrogen Peroxide," *Jet Propulsion*, p 666, June 1957.
5. Rusek, J.J., M.K. Minthorn, et al, "Non-Toxic Homogeneous Miscible Fuel (NHMF) Development for Hypergolic Bipropellant Engines," *Proceedings of the 6th Annual AIAA/BMDO Technology Readiness Conference*, San Diego CA, August 1997.
6. Anon., "Hydrogen Peroxide Handbook," Rocketdyne document number R-6931, Air Force Rocket Propulsion Laboratory report nr AFRPL-TR-67-144, 1967.
7. Monger, James M., "Sealed Storage of Concentrated Hydrogen Peroxide," *Chemical Propulsion Information Agency*, Publication No. 72, paper no. 69-1130I, 1965.
8. McCormick, J.C., "Hydrogen Peroxide Rocket Manual," FMC Corporation, circa 1963.
9. Whitehead, J.C., "Self-Pressurizing HTP Feed Systems," *Second International Hydrogen Peroxide Propulsion Conference*, Purdue University, Nov 7-11 1999.
10. Butler, K., "AR2-3 Engine Refurbishment and Gas Generator Testing," *AIAA 99-2738*, 1999.